

# PowerPorter 5.0

## User Manual

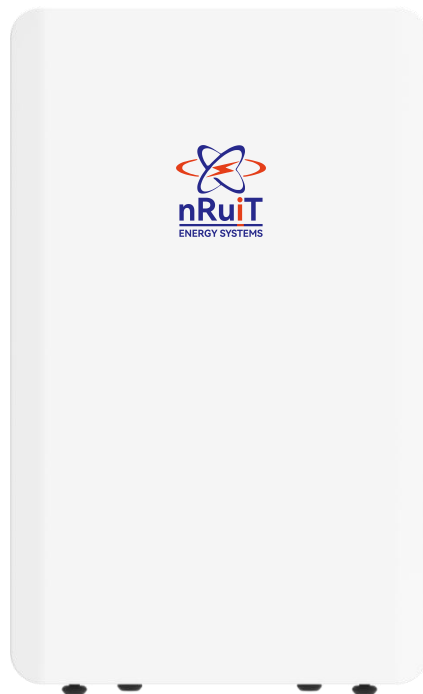

Version 2.0



nRuiT strongly advises to take due care in following the User manual. A warranty claim is invalid if damage is caused by human error, inconsistent.

For the latest Powerporter documents including the Warranty, visit [www.xinrex.com.cn](http://www.xinrex.com.cn).

	<p>Read this entire document before installing or using Powerporter. Failure to do so or to follow any of the instructions or warnings in this document can result in electrical shock, serious injury, or death, or can damage Powerporter.</p>
---	--

## PRODUCT SPECIFICATIONS

This manual applies to the product: Powerporter 5.0

All specifications and descriptions contained in this document are verified to be accurate at the time of printing. However, because continuous improvement is a goal at nRuiT, we reserve the right to make product modifications at any time.

The images provided in this document are for demonstration purposes only. Depending on product version, details may appear slightly different.

## ERRORS

To communicate any inaccuracies in this manual, send an email to:

[service@nruiT-power.com](mailto:service@nruiT-power.com)



### **ELECTRONIC DEVICE: DO NOT THROW AWAY**

Proper disposal of batteries is required. Refer to your local distributor for disposal requirements.





**MADE IN CHINA**

© 2023 nRuiT Energy All Rights Reserved

All information in this document is subject to copyright and other intellectual property rights of nRuiT. This material cannot be modified or copied; additional information may be provided upon request.

The following are trademarks or registered trademarks of nRuiT Energy in China and Other Countries.

nRuiT	Powerporter		
-------	-------------	--	---

All other trademarks contained in this document are the property of their respective owners and their use herein does not imply sponsorship or endorsement of their products or services. The unauthorized use of any trademark displayed in this document or on the product is strictly prohibited.

# TABLE OF CONTENTS

<b>IMPORTANT SAFETY INSTRUCTIONS</b> .....	1
Symbols In This Document.....	1
WARNING INFORMATION.....	1
CAUTION INFORMATION.....	2
REMARK INFORMATION.....	3
<b>1. Powerporter Warranty</b> .....	3
<b>2. Care And Maintenance</b> .....	4
Environmental Requirements.....	4
Care And Cleaning.....	4
Maintenance.....	4
<b>3. Powerporter Overview</b> .....	4
About Power Porter.....	4
Monitoring Your System.....	6
Abbreviation Of Manual.....	6
Product Label And Warning Label.....	7
List Of Goods.....	7
Install Fittings.....	8
Powerporter Installation Location.....	8
<b>4. Interface Definition</b> .....	9
Powerporter Interface Panel.....	9
LED Status Indicators.....	10
CAN/RS485 Interface Definition.....	11
<b>5. Connect To The Inverter</b> .....	11
Schematic Diagram Of Connection With Inverter - Simple Connection.....	11
Schematic Diagram Of Connection With Inverter - Recommended Connection.....	12
Powerporter Power Cable Connection.....	12
Parallel Operation.....	13
Compatible Inverter Brand.....	15
Powerporter On And Off.....	15
Powerporter Communication Interface.....	16
Operating.....	16
Trouble Shooting.....	16
Technical Support.....	17
<b>6. How To Deal With An Emergency</b> .....	17
<b>7. When The Product Is Turn Off And Not In Use</b> .....	18
<b>8. System Message</b> .....	18
<b>nRuiT Warranty Policy</b> .....	19

# IMPORTANT SAFETY INSTRUCTIONS

## SAVE THESE IMPORTANT SAFETY INSTRUCTIONS

Important: This product should not be used for any purpose other than that described in this user manual.

Powerporter installation and service require knowledge of high voltage electricity and should only be performed by nRuiT Certified Installers. Powerporter is not responsible for injuries or property damage caused by unqualified personnel trying to repair or failing to follow these instructions correctly. These warnings and cautions must be followed when using Powerporter.

## Symbols In This Document

This manual uses the following symbols to highlight important information:



Indicates a hazardous situation which, if not avoided, could result in death or serious injury.



Indicates that damage or injury may occur. situation which, if not avoided, it may cause minor injury and/or property damage.



Indicates a risk of possible damage to the product.



## WARNING INFORMATION

- Powerporter installation must be carried out only by nRuiT Certified Installers who have been trained.
- In the power regulation circuit, due to the high voltage, there is a high possibility of electric shock or severe burns.
- High voltage on AC and DC cables. There is a risk of death from electric shock or serious injury.
- There are potential dangers such as death or serious injury caused by fire, high pressure or explosion caused by this product, if you have not read or do not fully understand the appropriate preventive measures.
- Do not place flammable and explosive materials near the product.
- Do not place any objects on the product during operation.
- All the work of PV, power supply regulation and battery system must be completed by qualified personnel.
- Electrical installation must comply with local and national electrical safety standards.

- Wear rubber gloves and protective clothing (protective glasses and boots) when working on high-voltage / high-current systems (such as PCS and battery systems).
- Please do not remove the product cover, there is a risk of electric shock, and there are no user-usable parts inside. Request service from qualified and approved service technicians. Do not touch uninsulated wires.
- In the event of a failure, the system cannot be restarted. Product repairs must be performed by qualified personnel or authorized support center personnel.



## CAUTION INFORMATION

- The Powerporter and its accessories are contained in this box, the total weight is too large. Because the product is too heavy, it may cause serious injury. Therefore, special care must be taken when handling. Make sure that at least two people deliver and move the package.
- Do not use damaged, cracked or frayed cables and connectors. Protect the cable from physical or mechanical damage, such as the cable being twisted, twisted, clamped, closed on the door, or trampled by someone. Check the cable of your product regularly. If its appearance shows damage or deterioration, stop using this product and contact a qualified person to replace the cable.
- Make sure that the product you are connecting is grounded to prevent possible electric shock. Do not attempt to achieve grounding by connecting the product to telephone lines, lightning rods, or gas pipes.
- If the Powerporter is defective, cracked, broken or otherwise damaged or inoperable, please do not use the Powerporter again.
- This product should not come into contact with water (drip or splash), and should not place objects filled with liquids such as vases on this product.
- To prevent the risk of fire or electric shock, do not expose this product to rain or moisture.
- Keep out of reach of children or animals.
- Products must be handled in accordance with local regulations.
- The electrical installation of this device must be carried out by an electrician or technician with PCS qualification.
- To avoid radio interference, all accessories (such as smart meters) connected to the product must be suitable for residential, commercial and light industrial areas.
- Connect the DC+ and DC- cables to the correct DC+ and DC- terminals on the product.
- Do not step on the product or product packaging. The product may be damaged.

- Do not discard the battery in a fire. The battery may explode.
- Do not open or damage the battery. The electrolyte released may be toxic and harmful to the skin and eyes.
- Batteries are in danger of electric shock and large current discharge during short circuit. Pay attention to the following when installing the battery.
  1. Disassemble watches, rings or other metal objects.
  2. Use tools with insulated handles.
  3. Wear insulated gloves and boots.
  4. Do not place tools or metal parts on top of the battery.



## REMARK INFORMATION

- Before connecting, please make sure that the open circuit voltage of the photovoltaic array is within the acceptable range of the inverter to which the product is adapted, otherwise the product may be damaged.
- Never use any solvents, abrasives or corrosive substances to clean this product.
- Do not store or place any objects on the product. It may cause serious defects or malfunctions.
- Before connecting the product to the inverter terminal, make sure that the product is turned off, the inverter is turned off and the mains and PV channels are disconnected.
- The wiring terminal of the Powerporter product is only allowed to be connected to the adaptable inverter. Do not connect this product directly to the AC power supply or generator. Connecting the product to other external devices may cause serious damage to the device.
- The product transportation process should be as stable as possible, to avoid the product in the environment of severe vibration.
- The supply of products should be performed or supervised by personnel with battery knowledge and necessary precautions.

## 1. Powerporter Warranty

For specific warranty details, see the attached page of this document.

For more information, please refer to the Powerporter Warranty in your region.

[www.xinrex.com.cn](http://www.xinrex.com.cn)

## 2. Care And Maintenance

### Environmental Requirements

Powerporter can charge and discharge within the operating temperature range specified below. In extreme temperature ranges, Powerporter may limit the power of the battery when charging or discharging to improve battery life.

Battery Pack Operating Temperature	Charging: 0°C to 55°C Discharging: -20°C to 60°C
Battery Pack Storage Temperature	-10°C to 45°C



REMARKS

The Powerporter needs to keep the ambient temperature within the range of 0°C~45°C during startup.

### Care And Cleaning

If installed outdoors, please ensure that there are no leaves and other debris around the Powerporter to maintain optimal airflow.



CAUTION

Do not lean, stack, or hang anything around Powerporter and from wires to Powerporter.



CAUTION

When cleaning the Powerporter, use a soft, lint-free cloth. It is recommended to use dry and soft cloth, if necessary, only moisten with mild water.



CAUTION

Do not use cleaning solvents to clean Powerporter, or expose Powerporter to flammable or harsh chemicals or vapors.

### Maintenance

The only maintenance required by the user for the Powerporter is to keep the Powerporter free of debris.

## 3. Powerporter Overview

### About Power Porter

This product is mainly combined with inverter, photovoltaic (PV) and related accessories to build residential energy storage system. The system is used to store the power generated by PV to the connected battery and convert the direct current (DC) generated by the connected battery into alternating current (AC) and provide it to the home grid.

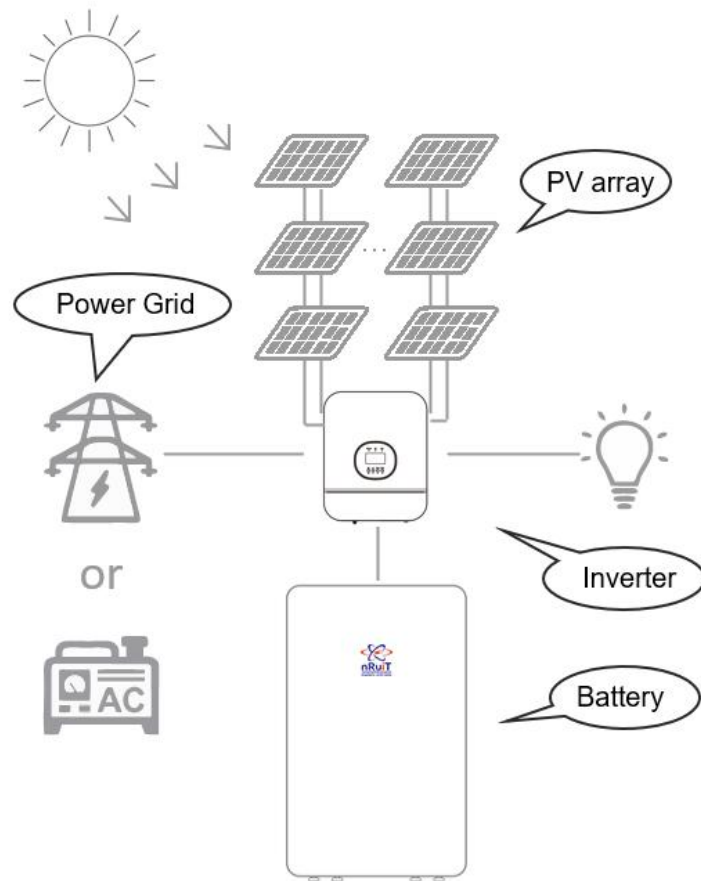

(Note: The actual Residential ESS may also include electrical equipment such as distribution boxes and metering meters)

Powerporter is a lithium-ion battery that can store electrical energy and outputs DC current. Powerporter only maintains electrical connection with the inverter. The electrical energy generated by the PV is converted by the inverter DC to DC and stored in the connected Powerporter. When Powerporter is needed, Powerporter's electrical energy is converted by the inverter DC to AC and transmitted to the home grid to provide power for household appliances.

The main function of the home energy storage system depends on the inverter. Powerporter is a device that stores electrical energy.

Functions of home ESS:

- Self-production and sales of electrical energy  
Use solar power and Power Porter to reduce the dependence on the grid and store electricity during the day for night use.
- Backup power  
When the power grid is out of power, it can be seamlessly switched to Power Porter as a backup power source to protect your home from power outages.
- Sell electrical energy  
The electrical energy generated by the photovoltaic array can be stored in a connected Powerporter or sold to an energy supply company.



- Off-grid power supply  
The system can be connected to diesel generators to ensure uninterrupted power supply in areas without city power (such as islands and remote mountain areas).

(Note: The scheduling management of electrical energy in the system depends on the inverter. Powerporter is committed to being compatible with a variety of inverters. The inverter you use does not necessarily contain all the above functions)

### Monitoring Your System



Using the app, you can monitor system operation from your mobile device, including the following:

- Real-time power usage
- Energy consumption history
- Relative amounts of energy used from solar, grid, and Powerporter storage



### Abbreviation Of Manual

Abbreviation	Full Name	Explanation
ESS	Energy Storage System	System for storing energy to battery and using energy stored in battery.
PV	Photovoltaic	Photovoltaic system that converts solar energy into direct current.
SOC	State of charge	Current battery level
BMS	Battery Management System	Lithium battery management system
DC	Direct Current	-
AC	Alternating Current	-

# Product Label And Warning Label

Model Name :	Powerporter 5.0
Battery Type :	Li-ion / LiFePO4
Rated Energy :	5.1kWh
Capacity / Voltage :	100Ah/51.2V
Charge Voltage :	51.5V~54V
Max. Continuous DC Power :	5kW
Series Number :	□

www.xinrex.com.cn  
DONGGUAN NRUIT ENERGY TECHNOLOGY CO., LTD

 **DANGER / LOW DC VOLTAGE INSIDE**

- Do not disconnect or disassemble by non-professional personnel.
- Do not install this product in the place exposed to the direct sunlight.
- Do not place near open flame or incinerate. It may lead to fire or explosion.
- Keep this product away from moisture or liquid.
- Do not attempt to break open this product. The product is only serviceable by certified personnel.
- Do not touch or use if liquids was spilled on it.
- Do not sit or put heavy things on the product.
- Single person lift could cause injury. Use assistance when moving or lifting.
- Follow the product manual to make wiring connection.
- Keep out of reach of children or animals.
- f leaking, fire, wet or damaged, switch off the breaker on DC side and stay away from the product.
- Contact your supplier within 24 hour if anything failure happens.



## List Of Goods



Powerporter



Power Cables×2

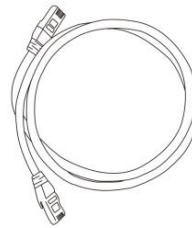

COM Cable×1

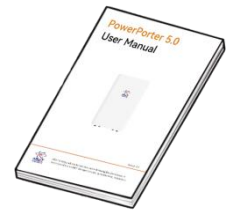

User Manual×1

No.	Project	Explanation
1	Powerporter	Energy storage battery.
2	Power Cables×2	Connect with the inverter to carry out power transmission with it.
3	COM Cable×1	Connect with inverter and communicate with it.
4	User Manual×1	-

## Install Fittings

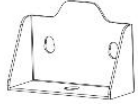

Support\_1



Support\_2x2

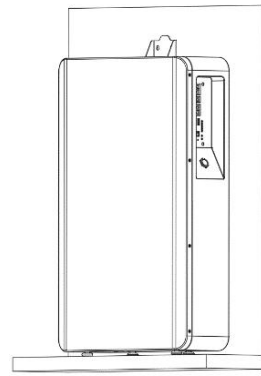

Floor-Mount

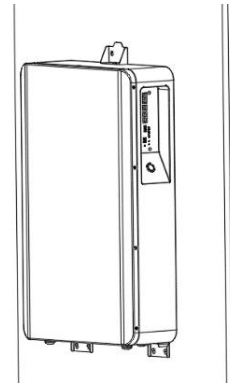

Wall-Mount

## Powerporter Installation Location

The product installation must meet the requirements described below.

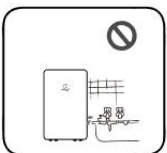
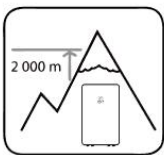
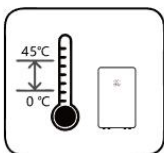
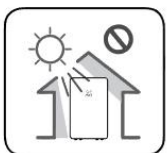
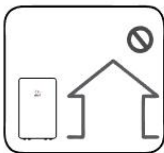

- This product is recommended for indoor use. If the product is installed outdoors, it must be ensured that the product is not exposed to direct sunlight, wetted by liquid, or blown by strong wind under any circumstances.
- It is recommended to install this product in the place where photovoltaic cables, mains cables and capacity are arranged.
- This product is only suitable for vertical wall-to-wall installation. Do not lay this product on the ground.
- The mounting surface must be able to bear this weight. Product (~53kg).
- The suitable operating temperature of the product is 0°C~45°C.
- Do not install this product in direct sunlight.
- Install the product in a clean and cool room.
- This product must not be installed or used at an altitude of more than 2000 meters.
- Do not install this product in the place where frequent flooding occurs.
- Do not install this product in a bathroom with high humidity.
- This product generates low noise at a specific time, and the installation location needs to consider sound insulation.
- The noise level may vary depending on the installation location.
- Do not install the product where there is vibration.
- Do not install this product in the place with ammonia, corrosive steam, acid or salt.
- Installed out of the reach of children and pets.
- Do not install this product in places and environments where large amounts of dust are likely to accumulate.

## 4. Interface Definition

### Powerporter Interface Panel

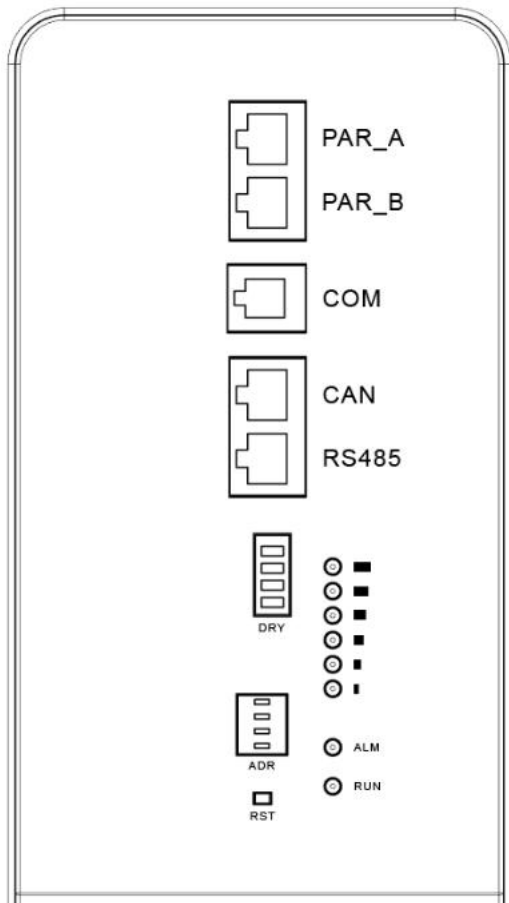

No	Project	Explanation
1	PAR_A	Parallel Port A
2	PAR_B	Parallel Port B
3	COM	DEBUG
4	CAN	Communication with Inverter
5	RS485	Communication with Inverter
6	DRY	Dry contact
7	ADR	Address definition
8	RST	Product reset
9	RUN	Run LED
10	ALM	Alarm LED
11	SOC LED	SOC LED

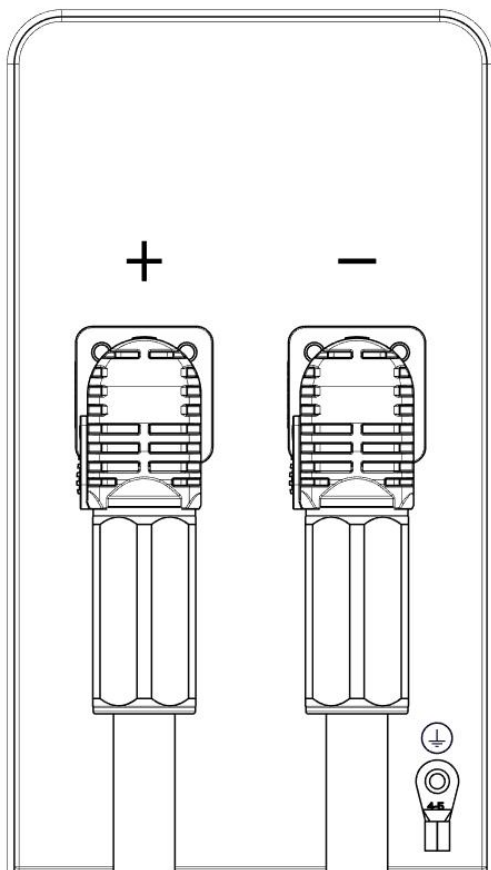

No	Project	Explanation
12	+	Positive
13	-	negative
14	GND	Ground
15	POWER	Power on/off

# LED Status Indicators

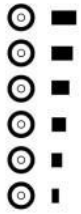

ALM  
RUN



Battery Status	SOC	POWER	RUN	ALM	SOC LED					
		●	●	●	●	●	●	●	●	●
Power off	/	●	●	●	●	●	●	●	●	●
Standby	83%≤SOC≤100%	●	Blinking	●	●	●	●	●	●	●
	66%≤SOC < 83%	●	Blinking	●	●	●	●	●	●	●
	50%≤SOC < 66%	●	Blinking	●	●	●	●	●	●	●
	33%≤SOC < 50%	●	Blinking	●	●	●	●	●	●	●
	16%≤SOC < 33%	●	Blinking	●	●	●	●	●	●	●
	0% < SOC < 16%	●	Blinking	Blinking	●	●	●	●	●	●
	SOC = 0 %	●	Blinking	Blinking	●	●	●	●	●	●
Charge	SOC = 100%	●	●	●	●	●	●	●	●	●
	83%≤SOC < 100%	●	●	●	●	●	●	●	●	Blinking
	66%≤SOC < 83%	●	●	●	●	●	●	●	Blinking	●
	50%≤SOC < 66%	●	●	●	●	●	●	Blinking	●	●
	33%≤SOC < 50%	●	●	●	●	●	Blinking	●	●	●
	16%≤SOC < 33%	●	●	●	●	Blinking	●	●	●	●
	0% < SOC < 16%	●	●	Blinking	Blinking	●	●	●	●	●
Discharge	83%≤SOC < 100%	●	Blinking	●	●	●	●	●	●	●
	66%≤SOC < 83%	●	Blinking	●	●	●	●	●	●	●
	50%≤SOC < 66%	●	Blinking	●	●	●	●	●	●	●
	33%≤SOC < 50%	●	Blinking	●	●	●	●	●	●	●
	16%≤SOC < 33%	●	Blinking	●	●	●	●	●	●	●
	0% < SOC < 16%	●	Blinking	Blinking	●	●	●	●	●	●
	SOC = 0 %	●	●	●	●	●	●	●	●	●
Protection	/	●	●	●	●	●	●	●	●	
Failure	/	●	●	●	●	●	●	●	●	

## CAN/RS485 Interface Definition

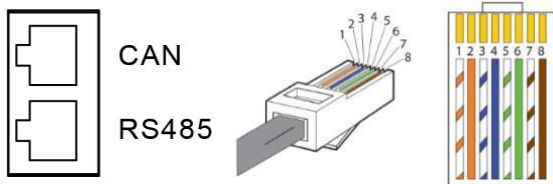

### Pin Definition

CAN		RS485	
Pin	Define	Pin	Define
1、2、3、6、8	NC	9、16	RS485-B1
5	CAN-L	10、15	RS485-A1
4	CAN-H	11、14	GND
7	GND	12、13	NC

## 5. Connect To The Inverter

### Schematic Diagram Of Connection With Inverter - Simple Connection

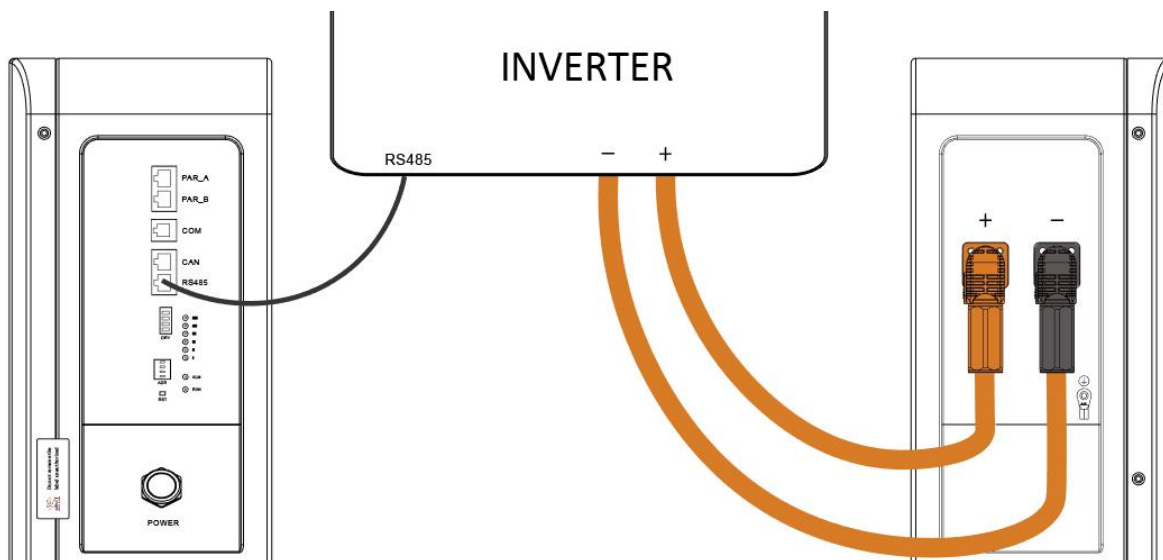

## Schematic Diagram Of Connection With Inverter - Recommended Connection

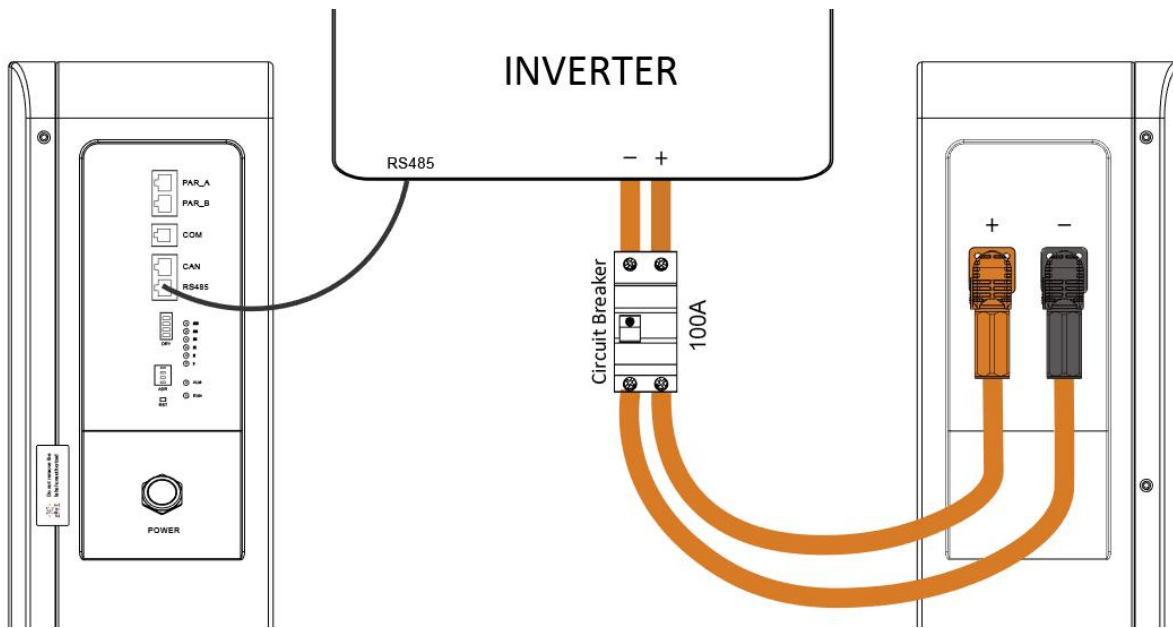

### Powerporter Power Cable Connection

The positive and negative poles of the Powerporter adopt a quick-plug interface, and the positive and negative poles can be distinguished by color (orange indicates the positive pole, black indicates the negative pole), and the installer can directly connect the power cables to the positive and negative poles of the product when wearing protective gloves.

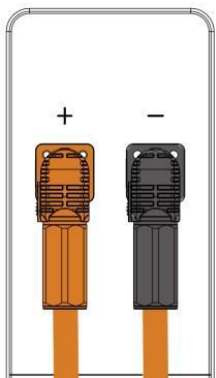

The power cable is connected with the Powerporter through a quick-plug interface, and connected with the inverter through a ring terminal.

Insert the ring terminal of the power cables into the battery connection port of the inverter, and ensure that the bolts are tightened with a torque of 2~3Nm. Make sure the polarity of the battery charge is properly connected, and the ring terminal is tightened with the inverter end.

Power cables connection steps:

- ① Confirm that the inverter mains line is open and the PV line is open. Confirm that Powerporter is shut down.
- ② The ring terminal of the wiring cables is connected to the positive and negative poles of the DC terminal of the inverter.
- ③ The negative quick connector is connected to the negative port of Powerporter.
- ④ The positive quick connector is connected to the positive port of the Powerporter.



Before the installation of the power cables, the Powerporter and the inverter must be turned off.

Power cables disconnection steps:

- ① Make sure the mains line is open, and the PV line is open.
- ② Turn off the inverter switch.
- ③ Press the POWER button to turns off Powerporter.
- ④ Remove the quick plug connector of the negative power cables.
- ⑤ Remove the quick plug connector of the positive power cables.
- ⑥ Remove the ring terminal of the power cables.



Follow the steps strictly. And make sure the interface is in good contact.



The installation and disconnection of the wiring cables should be operated by qualified installers, and the user must not operate in private.



The power cables may transmit large currents. Please make sure that the children cannot touch the power Cable.

## Parallel Operation

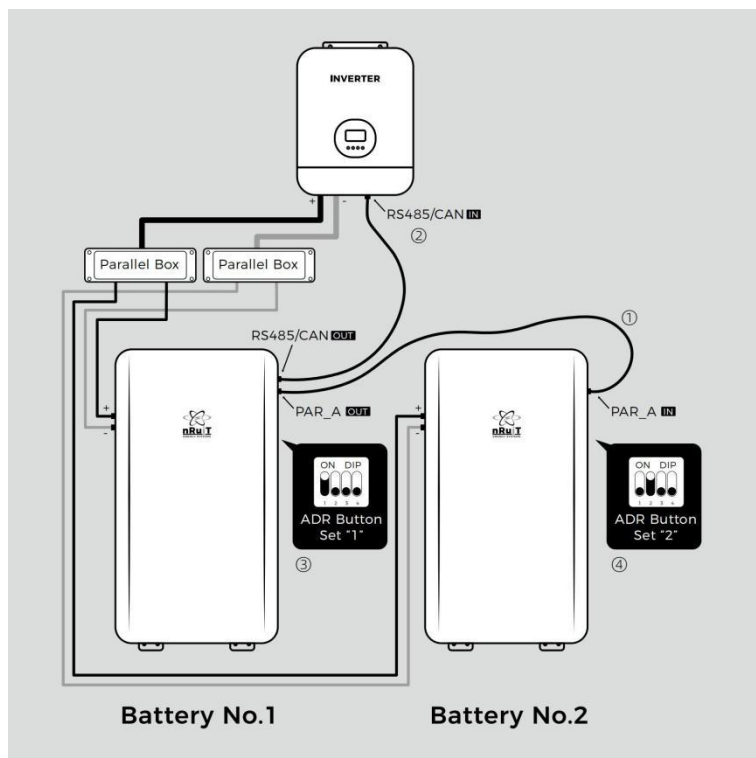

Two Battery and One Inverter

- ① Connect [PAR\_A] of battery 1 to [PAR\_A] of battery 2.
- ② Connect [RS485/CAN] of battery 1 to [RS485/CAN] of inverter.
- ③ Set the Button-ADR of battery 1 to "1".
- ④ Set the Button-ADR of battery 2 to "2".



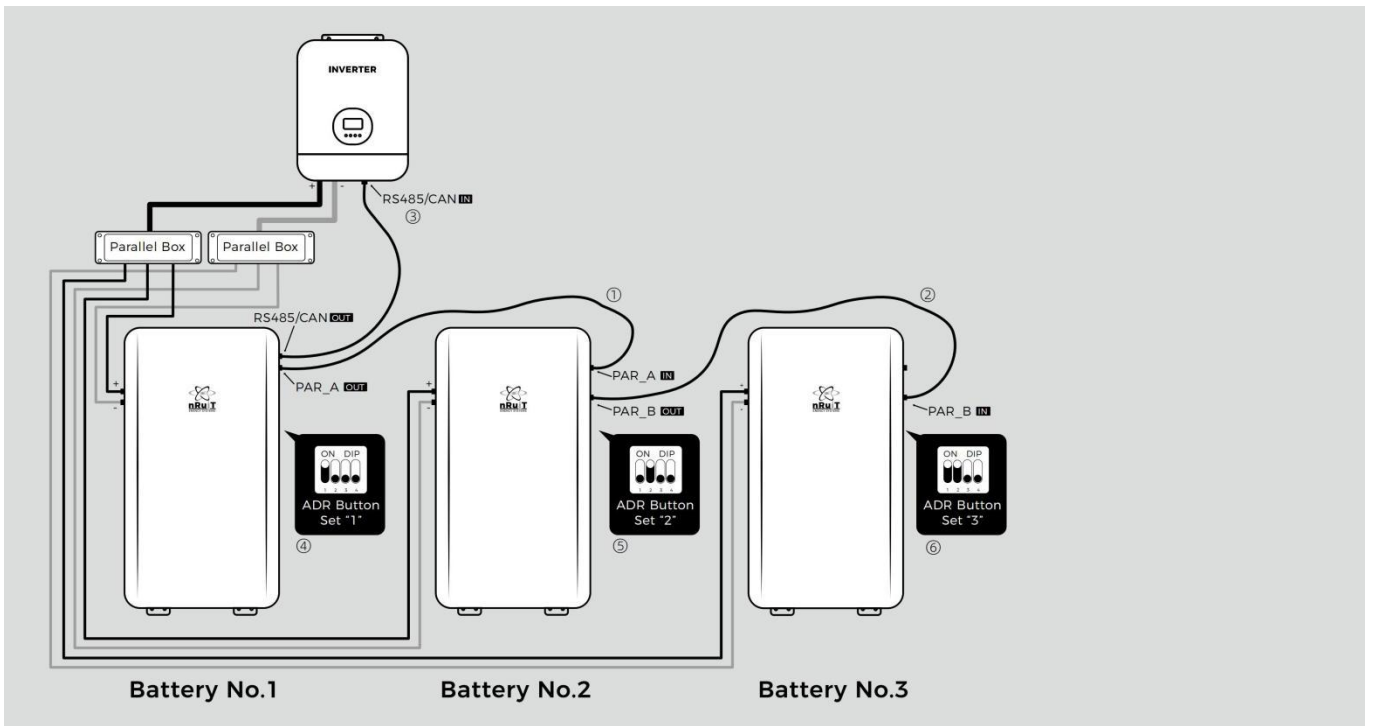

### Three Battery and One Inverter

- ① Connect [PAR\_A] of battery 1 to [PAR\_A] of battery 2.
- ② Connect [PAR\_B] of battery 2 to [PAR\_B] of battery 3.
- ③ Connect [RS485/CAN] of battery 1 to [RS485/CAN] of inverter.
- ④ Set the Button-ADR of battery 1 to "1".
- ⑤ Set the Button-ADR of battery 2 to "2".
- ⑥ Set the Button-ADR of battery 3 to "1" and "2".

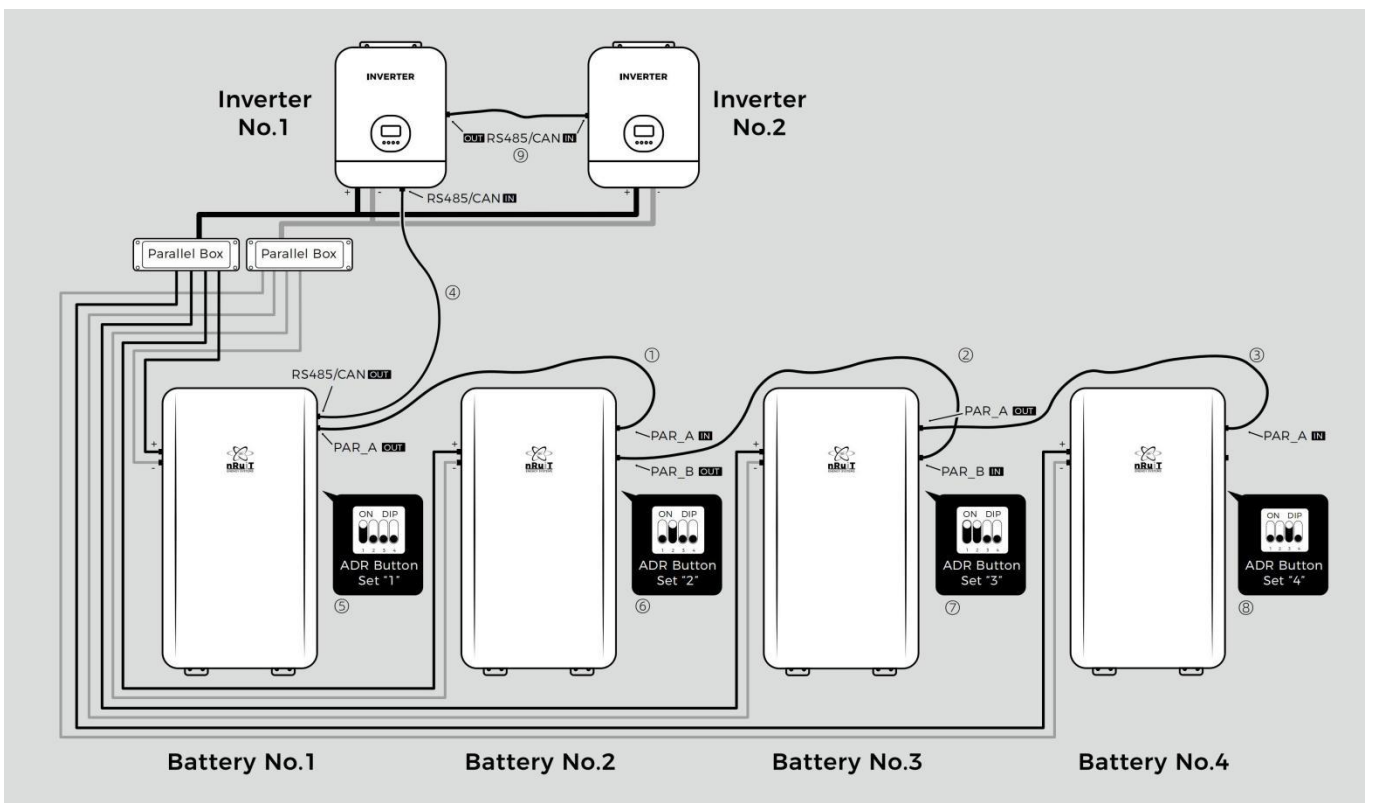

## Four Battery and Two Inverter

- ① Connect [PAR\_A] of battery 1 to [PAR\_A] of battery 2.
- ② Connect [PAR\_B] of battery 2 to [PAR\_B] of battery 3.
- ③ Connect [PAR\_A] of battery 3 to [PAR\_A] of battery 4.
- ④ Connect [RS485/CAN] of battery 1 to [RS485/CAN] of inverter 1.
- ⑤ Set the Button-ADR of battery 1 to "1".
- ⑥ Set the Button-ADR of battery 2 to "2".
- ⑦ Set the Button-ADR of battery 3 to "1" and "2".
- ⑧ Set the Button-ADR of battery 4 to "3".
- ⑨ Connect [BMS] of Inverter 1 to [BMS] of Inverter 2.

## Compatible Inverter Brand

The following inverter brands have been tested by nruit laboratory and can be perfectly compatible with powerporter.

Compatibility List of nRuiT ESS and Inverters

Inverter Brand	Inverter Type	Communication
Growatt	SPF5000 ES & SPF5000 HVM	CAN
LuxPower	SNA5000	CAN
LuxPower	LXP-5K Hybrid	CAN
TBB	Apollo Max 3.0&5.0	CAN
Deye	SUN-5K-SG03LP1-EU	CAN
GoodWe	GW5048D-ES	CAN
MEGAREVO	R5KLNA	CAN
SRNE	HF4850S80	RS485
Megarevo	R8KL1	CAN



Ensure that the maximum continuous charge and discharge power of DC terminal is less than 5000W during Powerporter operation.

## Powerporter On And Off



## Startup steps:

- ① Make sure the power cable is properly connected
- ② Press the POWER button.
- ③ Product boot



Before the product is turned on, the internal relay of the battery will produce sound when it is switched on / off, which is normal.

## Shutdown steps:

- ① Press the POWER button.
- ② Make sure the power cable is disconnected.
- ③ Product shutdown.



Before the product is turned off, the internal relay of the battery will produce sound when it is switched on / off, which is normal.



The power-on and power-off actions of the POWER button are not emergency operations for security incidents. If there is a safety problem in the home energy storage system, please disconnect the leakage switch and isolation switch (in the distribution box) in time. (Confirmation required).

## Powerporter Communication Interface

Both CAN and RS485 interfaces are responsible for the communication with the inverter, which is determined according to the adaptable inverter. See CAN/RS485 interface definition table.

## Operating

The inverter provides control and monitoring capabilities through the application program. During normal operation, the Powerporter is controlled by the inverter, and the power button of the Powerporter should remain on.



Do not try to use third-party tools and diagnostic tools to communicate with Powerporter between Powerporter and the inverter.

## Trouble Shooting

If the system is not working properly, please perform the following steps:



Powerporter and inverter cannot be repaired by users, and must be repaired by certified installers.



If the Powerporter failure causes downtime and cannot be resolved in time, please report to nRuiT or nRuiT authorized service partner in time. If not reported to nRuiT or nRuiT authorized service partner within 2 weeks after the failure, the warranty is invalid.

- If you cannot communicate with the inverter through the application, make sure that the

Internet connection is normal.

- If neither the inverter nor the power switch responds:
  1. Turn off the inverter
  2. Cut off all input and output circuit breakers in the distribution box
  3. Press the POWER button to turn off Powerporter
  4. Wait at least one minute
  5. Press the POWER button to turn on the Powerporter
  6. Close the inverter switch and all input and output circuit breakers.

Note: If an event (such as a thunderstorm) causes the system to become unresponsive. Do the following:

1. Turn off the inverter.
2. Open all input and output circuit breakers in the distribution box.
3. Make sure there is no electrical connection with Powerporter.
4. Press POWER button to close Powerporter.
5. Contact nRuiT support or nRuiT authorized dealer for help.

## Technical Support

If you need further assistance, please contact the nRuiT service team via the support phone in your area, or send an email to: [service@nrui-power.com](mailto:service@nrui-power.com)

When contacting nRuiT, please provide the following information:

- Name of owner.
- Your effective way (phone, mobile phone or email) can let nRuiT contact.
- Powerporter serial number
- Brief description of the problem.

## 6. How To Deal With An Emergency

If your health or safety is threatened, please always start with the following two steps before dealing with the following other suggestions:

1. Contact the fire department or other emergency team immediately.
2. Inform all people who may be affected to ensure that they can evacuate the area.



The actions suggested below can only be performed under safe conditions.

In case of fire:

- Turn off the inverter
- Press POWER button to turn off Powerporter
- Cut off all input and output circuit breakers in the distribution box
- Acceptable fire extinguisher types include: water, CO<sub>2</sub>, and ABC fire extinguishers

Avoid using type D (flammable metal) fire extinguishers.

In case of flood:

- If any part of the battery and inverter or wires are submerged in water, please keep away from water.
- Turn off the inverter

- Press POWER button to turn off Powerporter.
- Cut off all input and output circuit breakers in the distribution box.
- Make sure there is no electrical connection with Powerporter.
- If possible, protect the system by finding and stopping the water source and pumping the water away.
- Contact nRuiT technical support or nRuiT authorized dealers for help in time.

If there is odor or smoke:

- Turn off the inverter.
- Press POWER button to turn off Powerporter.
- Cut off all input and output circuit breakers in the distribution box.
- Make sure there is no electrical connection with Powerporter.
- Ventilate the room and contact nRuiT technical support or nRuiT authorized dealers for help in time.

If Powerporter makes abnormal noise:

- Turn off the inverter.
- Press POWER button to turn off Powerporter.
- Cut off all input and output circuit breakers in the distribution box.
- Make sure there is no electrical connection with Powerporter.
- Contact nRuiT technical support or nRuiT authorized dealers for help in time.

## 7. When The Product Is Turn Off And Not In Use

Powerporter is a lithium-ion battery product and should not be stored for a long time. Regardless of the reasons why the product is shut down and not used, please observe the Powerporter storage requirements in the following table.

Storage Temperature	Short-term storage of less than 1 month	-10°C to +45°C
	Long-term storage of no more than 3 months	0°C to +45°C



Do a full charge and discharge of the battery before the storage of the product expires, and the final charge SOC remains at about 50%.

## 8. System Message

The serial number of the product is on the Powerporter label. If your system needs repair, please keep this information.

# nRuiT Warranty Policy

## (Product Name: Powerporter 5.0)

This Limited Warranty (hereinafter referred to as "Warranty") specified below is applicable to nRuiT energy storage batteries system (hereinafter referred to as "Products") provided by Dongguan nRuiT Energy Technology Co, Ltd. (hereinafter referred to as "nRuiT" or "Seller") to End-user (hereinafter referred to as "Buyer") through nRuiT or Authorized Reseller.

### 1. Purpose

"The main objective of this warranty policy is to provide a clear understanding of the matters related to the warranty of our products."

### 2. Warranty Condition

nRuiT warrants that, under normal use, the Product will be free from defects in material and workmanship in accordance with its applicable technical specifications.

#### 2-1. Warranty Start Date

Generally, Warranty Start Date is the installation date, which is written on the warranty card. Alternatively, the buyer can provide written documents such as a receiving note to indicate the Delivery Date - the time when the product was delivered to the installation site and operated for the first time.

If the buyer cannot provide the above documents to prove the "Installation date" or "Delivery Date", the Warranty Start Date will be the first day after six (6) months from the Production Date of the Product (date written on the product SN label).

#### 2-2. Limited Product Warranty

nRuiT warrants that the Product will be free from defects in materials or workmanship for five (5) years from Warranty Start Date, subject to the exclusions and limitations set out below.

#### 2-3. Limited Performance Warranty

- A. nRuiT warrants that the Product will (i) retain sixty percent (70%) of its Usable Energy for ten (10) years from the Warranty Start Date, or (ii) reach the Minimum Throughput Energy, whichever comes first, on the condition that the Product is operated in a normal manner that adheres to the manual guidelines provided by nRuiT.
- B. The Minimum Throughput Energy means the total output energy of the product recorded in the control module of the Product.
- C. The Usable Energy and Minimum Throughput Energy for each product Model are set in the table below.

Product Model	Usable Energy (kWh)	Minimum Throughput Energy(MWh)
Powerporter 5.0	5.12	16.39

D. For this Limited Warranty, the remaining Usable Energy is as measured and calculated using the following testing method and values, while the ambient temperature is between 25 to 28°C.

1. Discharge the battery with constant current until the battery reaches End of Discharge Voltage of its self-protective voltage.
2. Wait for 10 minutes.
3. Charge the battery with constant current and constant charge voltage to its full capacity.
4. Wait for 10 minutes.
5. Discharge the battery with constant current until it reaches End of Discharge Voltage of its self-protective voltage. Record the current, voltage, and time.
6. The remaining Usable Energy is the integral of discharge time and current multiplied by voltage. Test Value list as below:

Product Model	End of Discharge Voltage(V)	Constant Charge voltage(v)	Constant Current(A)
Powerporter 5.0	44.8	57.6	20

nRuiT provides two methods of Warranty if the product operation does not meet the technical specifications during the free Warranty period: (I) Repair the nonconforming or defective products, or (II) provide the buyer with replacement parts. nRuiT shall be responsible for all reasonable repair or replacement costs associated with such non-conforming or defective products, however, the buyer shall bear the cost of removing the defective products and re-installing the repaired or replacement products.

## 2-4. Limitation of Warranty Scope

nRuiT's liability under this Warranty shall be limited to replacement, repair, refund and compensation. Replaced or repaired Products shall be warranted for the remainder of the original Term of Warranty. In any event, the replacement shall not justify the automatic renewal or extending of the term of Warranty.

## 2-5. Exclusion of Warranty

Damage to the Products resulting from any of following activities is NOT covered by this Limited Warranty:

- The warranty period has expired.
- Improper transportation, storage, installation or wiring of the product.
- Modification, alteration, disassembly, repair works or replacements by someone other than personnel certified by nRuiT.
- Noncompliance with nRuiT's official installation, user guide and / or maintenance instructions.
- External influences, such as power failure surge, lightning, flood, fire, accidental damage or other events beyond nRuiT's control.
- Use of non-specified and / or incompatible components like batteries, inverters, rectifiers or PCS.
- Any damage to the product caused by goods / other products (including any part) incorporated, installed or used together with the products.
- No report to nRuiT or nRuiT authorized service partners within 2 weeks after product failure.
- Product defects due to the updating of national or regional laws and regulations.
- When the product is sold to the end user, the defects cannot be overcome under the technical conditions.
- The user fails to provide the correct product serial number or the product serial number cannot be decoded or modified without nRuiT's permission.
- When the product is turned off, it does not meet the storage requirements.

## **2-6. Warranty Service**

The buyer shall contact the installer directly to avoid additional problems with the product. Note: in shutdown mode, the product cannot protect itself from self-discharge.

## **3. Out of Warranty Policy**

Products damage which is not caused by seller, nRuiT shall provide charged service, including all the expenses of such as material cost, labor cost, warehouse cost, transportation cost, customs duties, analysis cost, management overheads, disposal expense (If necessary) and so on.

## **4. About Service Products/Parts**

Service products/parts are able to be used as new or refurbished condition which performance is equal to or higher than defective Products and guaranteed by nRuiT. In the event the Products are not available in the market anymore, nRuiT, at its option, may replace it with different kind of product with equivalent functions and performances.

## **5. Product Recycling Service**

Customers are provided with product recycling services after the end of product life cycle by nRuiT. The judgment condition at the end of the life cycle is that the existing maximum capacity of the product is less than or equal to 70% of the nominal capacity of the product.



## 6. Claim Payment Policy

Returns of any products will not be accepted unless nRuiT authorizes them in writing in advance. The written authorization shall include the product model name, defect and / or fault description, serial number on the product label on the back of the product and the installation date.

Buyers who are unable to contact the local authorized reseller from whom the Product was purchased should contact nRuiT by send mail to [service@nruiT-power.com](mailto:service@nruiT-power.com)

Note: Before returning any product to nRuiT please contact nRuiT by email.

## 7. Contact nRuiT

nRuiT Service E-mail : [service@nruiT-power.com](mailto:service@nruiT-power.com)

nRuiT Service Hotline:

Headquarters (China): +86 0769 28823662

## 8. Applicable Law

The Warranty is subject to the law of the region sold. Products come with guarantees that cannot be excluded under the local Law. The Buyer is entitled to a replacement or refund for a major failure and compensation for any other reasonably foreseeable loss or damage. The Buyer is also entitled to have the goods repaired or replaced if the Products fail to be of acceptable quality and the failure does not amount to a major failure. The benefits to the consumer given by the warranty are in addition to any other rights and remedies of the consumer under a law in relation to the goods or services to which the warranty relates. This Warranty only applies to the Buyer who have purchased the Products for their own use.

S/N Code:

The installation date: \_\_\_\_\_

User's Signature: \_\_\_\_\_

Installation contractors: \_\_\_\_\_

